

TOP VIEW

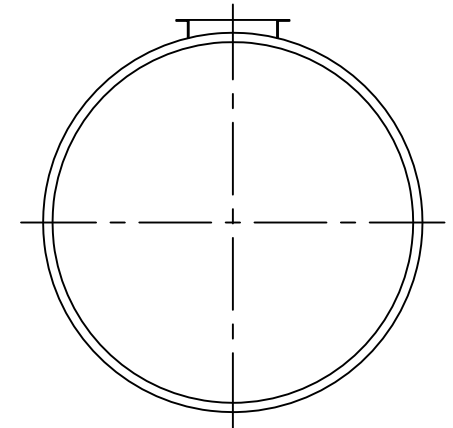

END VIEW

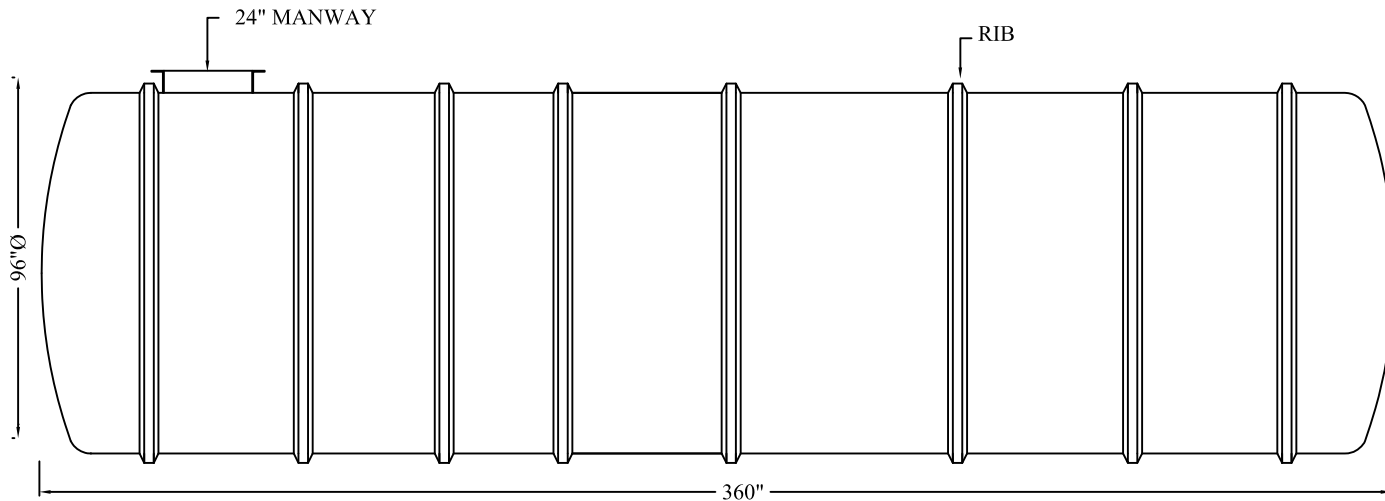

ELEVATION VIEW

MODEL FRP9000-8H
 FILAMENT WOUND
 FIBERGLASS TANK
 VOL. CAP. 9,000 I.GALS
 10,800 US GALS
 40,914 LITERS

NOTES:	<u>PROJECT</u>			
TOTAL VOLUME				
LITERS:				
I.GALS:				
LENGTH				
METRIC (mm):				
IMPERIAL:				
DATE:				
DRAWN BY:	REV No.	SCALE:	SHEET OF	DWG REF.
L J				



**CANWEST TANKS &
 ECOLOGICAL SYSTEMS LTD.**
 www.canwest-tanks.com