

TOP VIEW

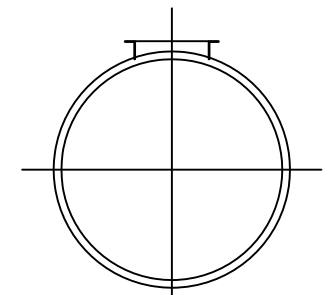

END VIEW

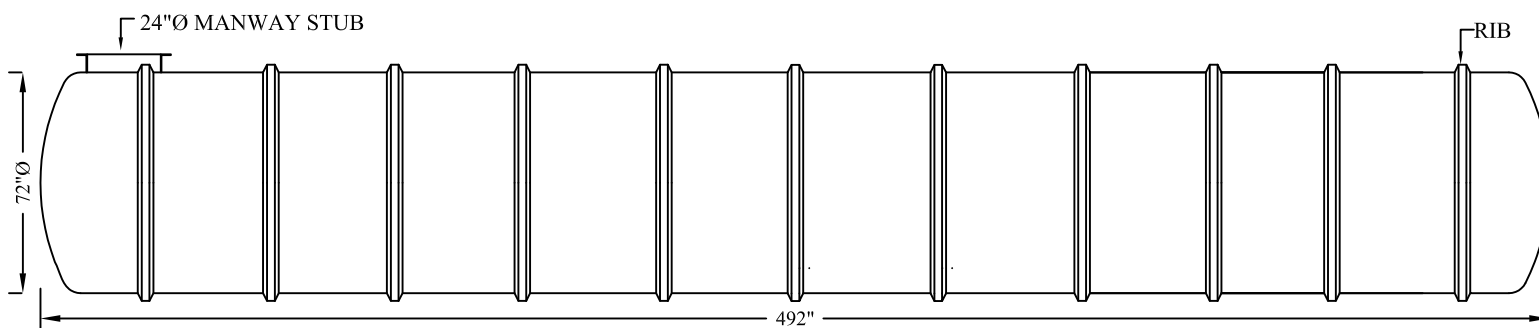

ELEVATION VIEW

MODEL FRP7000-6H
 FILAMENT WOUND FIBERGLASS TANK
 VOL. CAP. 7,000 I.GALS
 8,400 US GALS
 31,822 LITERS

NOTES:	<u>PROJECT</u>			
TOTAL VOLUME	 CANWEST TANKS & ECOLOGICAL SYSTEMS LTD. www.canwest-tanks.com			
LITERS:				
I.GALS:				
LENGTH	REV No.	SCALE:	SHEET	OF
METRIC (mm):				
IMPERIAL:				
DATE:				DWG REF.
DRAWN BY:				
L J				