

PLAN VIEW

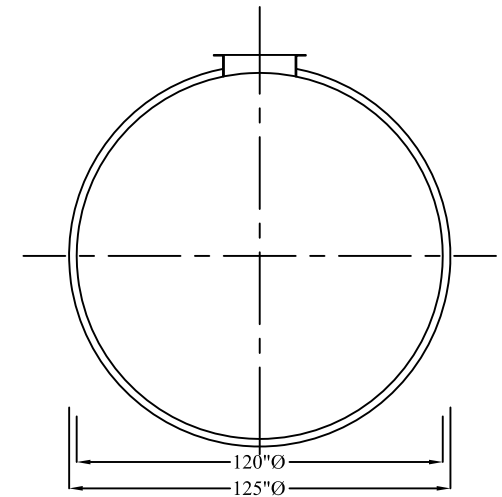

END VIEW

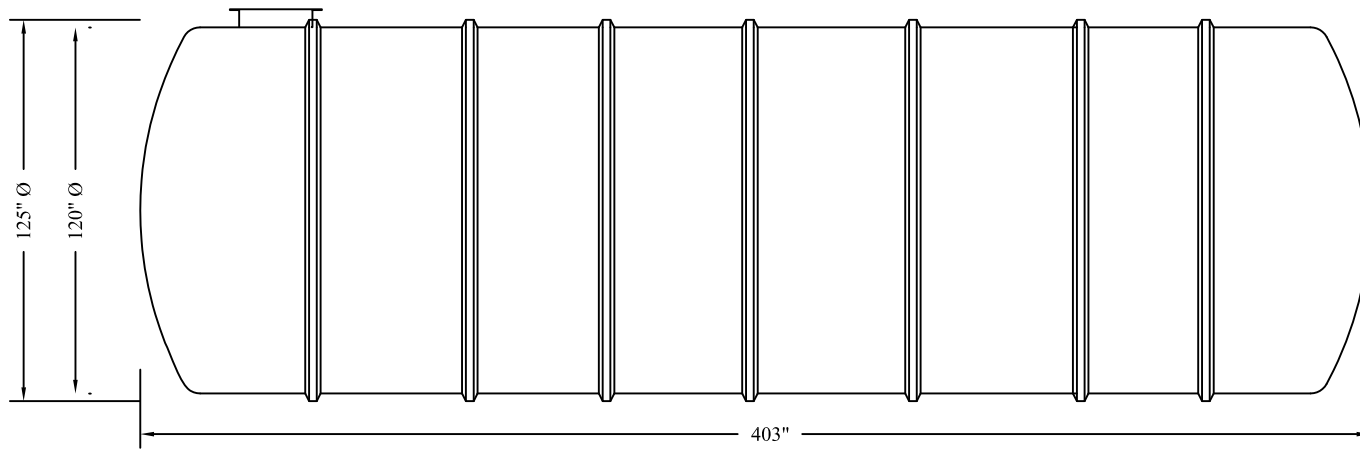

ELEVATION

FILAMENT WOUND FIBERGLASS TANK OPTIONS:

1. ABOVE OR BELOW GROUND INSTALLATION
2. POTABLE OR NON POTABLE WATER
3. FIRE PROTECTION
4. SEWAGE HOLDING OR SEPTIC TANK
5. HOLD-DOWN STRAPS FOR WATER TABLE CONDITIONS
6. SIZE OF MANWAY - TO SUIT APPLICATION
7. FITTINGS - FLANGED FRP
8. HEAT TRACE & INSULATION

MODEL No. FRP16000-10H
 TOT. CAP. - 16,000 gals

NOTES:	PROJECT			
TOTAL VOLUME				
LITERS:				
LGALS:				
LENGTH				
METRIC (mm):				
IMPERIAL (Ft.):				
DATE:	REV No.	SCALE:	SHEET OF	DWG REF.
DRAWN BY:	L J			



**CANWEST TANKS &
 ECOLOGICAL SYSTEMS LTD.**
 www.canwest-tanks.com